

Power Metal Film Resistors

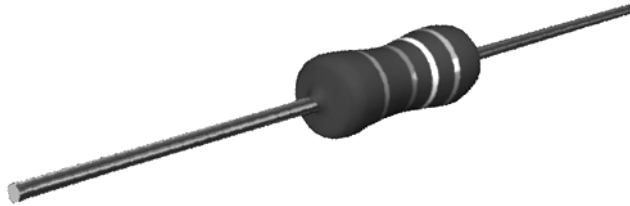

FEATURES

- High power in small packages
- Different lead materials for different applications
- Defined interruption behaviour.

APPLICATIONS

- All general purpose power applications

A homogeneous film of metal alloy is deposited on a high grade ceramic body. After a helical groove has been cut in the resistive layer, tinned connecting wires of electrolytic copper or copper-clad iron are welded to the end-caps. The resistors are coated with a red, nonflammable lacquer which provides electrical, mechanical and climatic protection. This coating is not resistant to aggressive fluxes. The encapsulation is resistant to all cleaning solvents in accordance with "MIL-STD-202E, method 215", and "IEC 60068-2-45".

TECHNICAL SPECIFICATIONS					
DESCRIPTION	VALUE				
	PR01	PR02		PR03	
		Cu-lead	FeCu-lead	Cu-lead	FeCu-lead
Resistance range ⁽³⁾	0.22 Ω to 1 MΩ	0.33 Ω to 1 MΩ	1 Ω to 1 MΩ	0.68 Ω to 1 MΩ	1 Ω to 1 MΩ
Resistance tolerance and series	± 1 % (E24, E96 series); ± 5 % (E24 series); see notes 1 and 2				
Maximum dissipation at T _{amb} = 70 °C:					
R < 1 Ω	0.6 W	1.2 W	–	1.6 W	–
1 Ω ≤ R	1 W	2 W	1.3 W	3 W	2.5 W
Thermal resistance (R _{th})	135 K/W	75 K/W	115 K/W	60 K/W	75 K/W
Temperature coefficient	≤ ± 250 × 10 ⁻⁶ /K				
Maximum permissible voltage (DC or RMS)	350 V	500 V		750 V	
Basic specifications	IEC 60115-1 and 60115-4				
Climatic category (IEC 60068)	55/155/56				
Stability after:					
load	ΔR/R max.: ± 5 % + 0.1 Ω				
climatic tests	ΔR/R max.: ± 3 % + 0.1 Ω				
soldering	ΔR/R max.: ± 1 % + 0.05 Ω				

Notes

1. 1 % tolerance is available for R_n-range from 1R upwards.
2. 2 % tolerance is available on request for R_n-range from 1R upwards.
3. Ohmic values (other than resistance range) are available on request.



12NC ORDERING CODE - indicating resistor type and packaging ⁽¹⁾ . Preferred types in bold								
TYPE	LEAD Ø (mm)	TOL (%)	ORDERING CODE 23... .. (BANDOLIER)					
			AMMOPACK				REEL	
			RADIAL TAPED		STRAIGHT LEADS			
			4000 units	3000 units	52 mm	52 mm	63 mm	52 mm
			5000 units	1000 units	500 units	5000 units		
PR01	Cu 0.6	1	-	-	22 196 1...	06 191 2...	-	06 191 5...
		5	06 197 03...	-	22 193 14...	06 197 53...	-	06 197 23...
PR02	Cu 0.8	1	-	-	-	22 197 1...	-	06 192 5...
		5	-	06 198 03...	-	06 198 53...	-	06 198 23...
	FeCu 0.6	5	-	-	-	22 194 54...	-	-
PR03	Cu 0.8	5	-	-	-	-	22 195 14...	-
		1	-	-	-	-	06 199 6...	-
	FeCu 0.6	5	-	-	-	-	22 195 54...	-

Note

1. Other packaging versions are available on request.

12NC ORDERING CODE - indicating resistor type and packaging. Preferred types in bold						
TYPE	LEAD Ø (mm)	TOL (%)	ORDERING CODE 23... .. (LOOSE IN BOX)			
			DOUBLE KINK			
			PITCH = 17.8 (mm)	PITCH = 25.4 (mm)	PITCH ⁽¹⁾⁽²⁾⁽³⁾	
			1000 units	500 units	1000 units	500 units
PR01	Cu 0.6	5	22 193 03...	-	-	-
	FeCu 0.6	5	22 193 43...	-	22 193 53... ⁽¹⁾	-
PR02	Cu 0.8	5	22 194 23...	-	-	-
	FeCu 0.6	5	22 194 83...	-	-	-
	FeCu 0.8	5	-	-	22 194 63... ⁽²⁾	-
PR03	Cu 0.8	5	-	22 195 23...	-	-
	FeCu 0.6	5	-	22 195 83...	-	-
	FeCu 0.8	5	-	-	-	22 195 63... ⁽³⁾

Notes

- PR01 pitch 12.5 mm.
- PR02 pitch 15.0 mm.
- PR03 pitch 20.0 mm, with reversed kinking direction as opposed to the drawing for the type with double kink figure.

ORDERING INFORMATION**Ordering Code (12NC)**

The resistors have a 12-digit ordering code starting with 23.

For 5 % tolerance:

- The first 9 digits indicate the resistor type and packaging.
- The remaining 3 digits indicate the resistance value:
 - The first 2 digits indicate the resistance value.
 - The last digit indicates the resistance decade.

For 1% tolerance:

- The first 8 digits indicate the resistor type and packaging.
- The remaining 4 digits indicate the resistance value:
 - The first 3 digits indicate the resistance value.
 - The last digit indicates the resistance decade.

Last Digit of 12NC Indicating Resistance Decade

RESISTANCE DECADE	LAST DIGIT
0.22 to 0.91 Ω	7
1 to 9.76 Ω	8
10 to 97.6 Ω	9
100 to 976 Ω	1
1 to 9.76 kΩ	2
10 to 97.6 kΩ	3
100 to 976 kΩ	4
1 MΩ	5

Ordering Example

The ordering code for resistor type PR02 with Cu leads and a value of 750 Ω with 5 % tolerance, supplied on a bandolier of 1000 units in ammopack, is: 2306 198 53751.

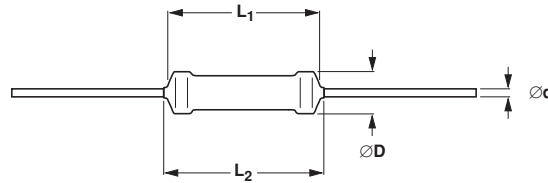
DIMENSIONS

Type with straight leads.

DIMENSIONS - straight lead type and relevant physical dimensions; see straight leads outline					
TYPE	ØD MAX. (mm)	L ₁ MAX. (mm)	L ₂ MAX. (mm)	Ød (mm)	
				Cu	FeCu
PR01	2.5	6.5	8.5	0.58 ± 0.05	-
PR02	3.9	10.0	12.0	0.78 ± 0.05	0.58 ± 0.05
PR03	5.2	16.7	19.5	0.78 ± 0.05	0.58 ± 0.05

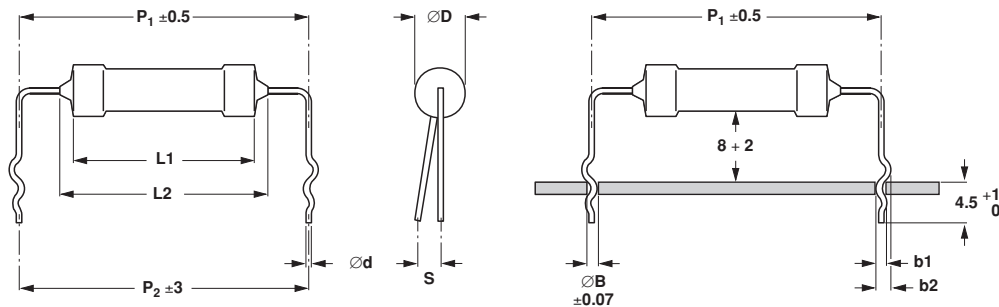

Type with double kink.

Dimensions in millimeters.

DIMENSIONS - double kink lead type and relevant physical dimensions; see double kinked outline										
TYPE	LEAD STYLE	Ød (mm)		b ₁ (mm)	b ₂ (mm)	ØD MAX. (mm)	P ₁ (mm)	P ₂ (mm)	S MAX. (mm)	ØB (mm)
		Cu	FeCu							
PR01	double kink large pitch	0.58 ± 0.05	0.58 ± 0.05	1.10 + 0.25/-0.20	1.45 + 0.25/-0.20	2.5	17.8	17.8	2	0.8
	double kink small pitch	-	0.58 ± 0.05	1.10 + 0.25/-0.20	1.45 + 0.25/-0.20		12.5	12.5	2	0.8
PR02	double kink large pitch	0.78 ± 0.05	0.58 ± 0.05	1.10 + 0.25/-0.20	1.45 + 0.25/-0.20	3.9	17.8	17.8	2	0.8
	double kink small pitch	-	0.78 ± 0.05	1.30 + 0.25/-0.20	1.65 + 0.25/-0.20		17.8	17.8	2	1.0
PR03	double kink large pitch	0.78 ± 0.05	0.58 ± 0.05	1.10 + 0.25/-0.20	1.65 + 0.25/-0.20	5.2	25.4	25.4	2	1.0
	double kink small pitch	-	0.78 ± 0.05	1.30 + 0.25/-0.20	2.15 + 0.25/-0.20		22.0	20.0	2	1.0



MASS PER 100 UNITS	
TYPE	MASS (g)
PR01	28
PR02	62
PR03	120

MARKING

The nominal resistance and tolerance are marked on the resistor using four coloured bands in accordance with IEC publication 60062, "Colour codes for fixed resistors".

OUTLINES

The length of the body (L_1) is measured by inserting the leads into holes of two identical gauge plates and moving these plates parallel to each other until the resistor body is clamped without deformation ("IEC publication 60294").

MOUNTING

The resistors are suitable for processing on automatic insertion equipment and cutting and bending machines.

FUNCTIONAL DESCRIPTION

PRODUCT CHARACTERIZATION

Standard values of nominal resistance are taken from the E96/E24 series for resistors with a tolerance of $\pm 1\%$ or $\pm 5\%$. The values of the E96/E24 series are in accordance with "IEC publication 60063".

FUNCTIONAL PERFORMANCE

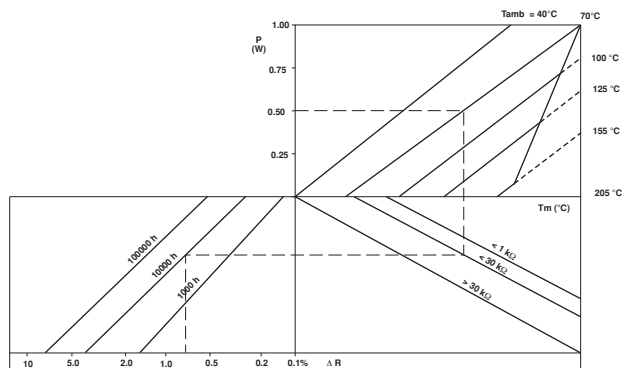

PR01 Drift nomogram.

MOUNTING PITCH			
TYPE	LEAD STYLE	PITCH	
		mm	e
PR01	straight leads	12.5 ⁽¹⁾	5 ⁽¹⁾
	radial taped	4.8	2
	double kink large pitch	17.8	7
	double kink small pitch	12.5	5
PR02	straight leads	15.0 ⁽¹⁾	6 ⁽¹⁾
	radial taped	4.8	2
	double kink large pitch	17.8	7
	double kink small pitch	15.0	6
PR03	straight leads	23.0 ⁽¹⁾	9 ⁽¹⁾
	double kink large pitch	25.4	10
	double kink small pitch	20.0	8

Note

1. Recommended minimum value.

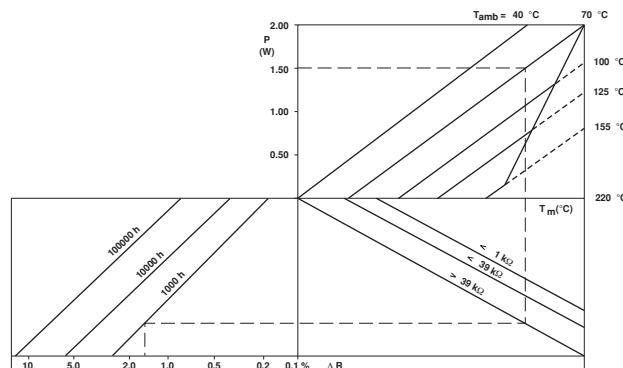

PR02 Drift nomogram.

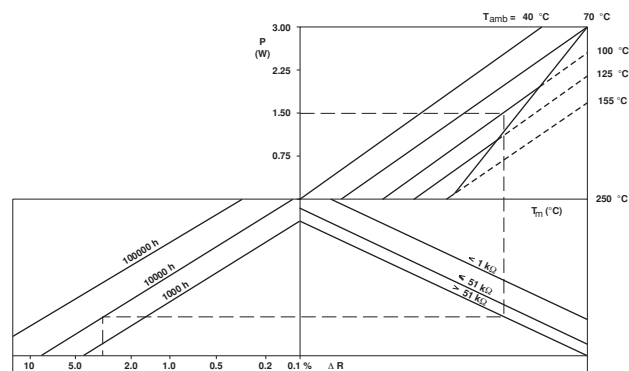

PR03 Drift nomogram.

LIMITING VALUES				
TYPE	LEAD MATERIAL	RANGE	LIMITING VOLTAGE ⁽¹⁾ (V)	LIMITING POWER (W)
PR01	Cu	$R < 1 \Omega$	350	0.6
		$1 \Omega \leq R$		1.0
PR02	Cu	$R < 1 \Omega$	500	1.2
	FeCu	$1 \Omega \leq R$		2.0
PR03	Cu	$R < 1 \Omega$	750	1.6
		$1 \Omega \leq R$		3.0
	FeCu	$1 \Omega \leq R$		2.5

Note

1. The maximum voltage that may be continuously applied to the resistor element, see "IEC publication 60115-1". The maximum permissible hot-spot temperature is 205 °C for PR01, 220 °C for PR02 and 250 °C for PR03.

The power that the resistor can dissipate depends on the operating temperature.

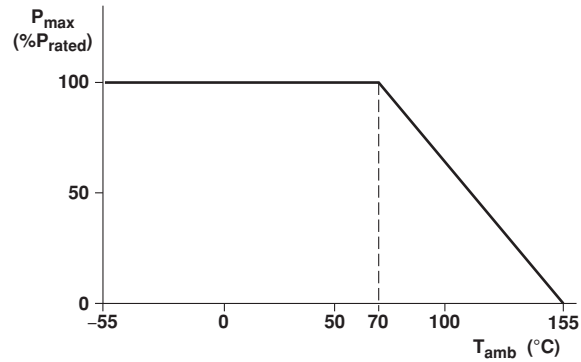

Maximum dissipation (P_{max}) in percentage of rated power as a function of the ambient temperature (T_{amb}).

Derating

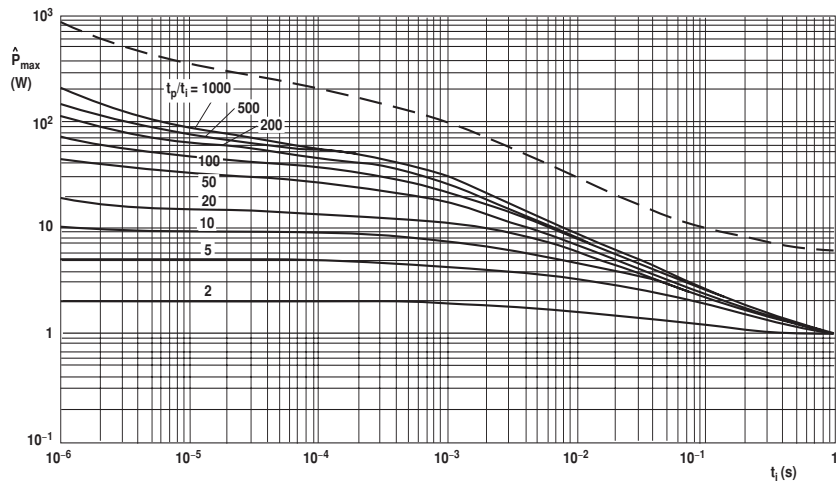

PR01 Pulse on a regular basis; maximum permissible peak pulse power (\hat{P}_{max}) as a function of pulse duration (t_i).

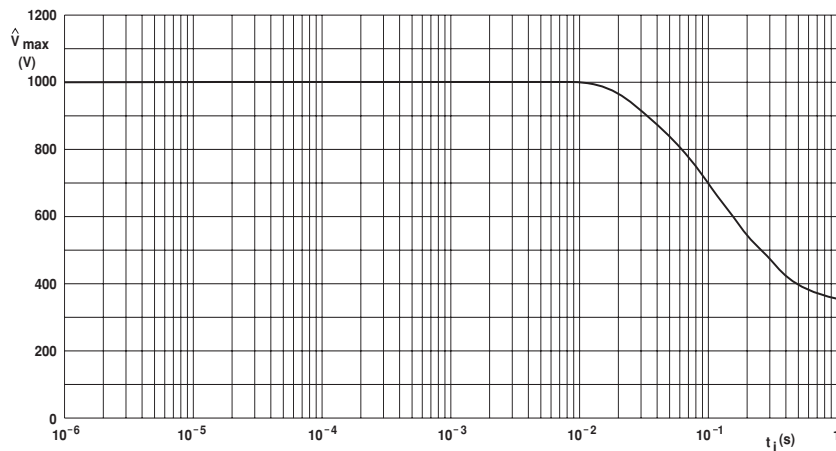

PR01 Pulse on a regular basis; maximum permissible peak pulse voltage (\hat{V}_{max}) as a function of pulse duration (t_i).

Pulse Loading Capabilities

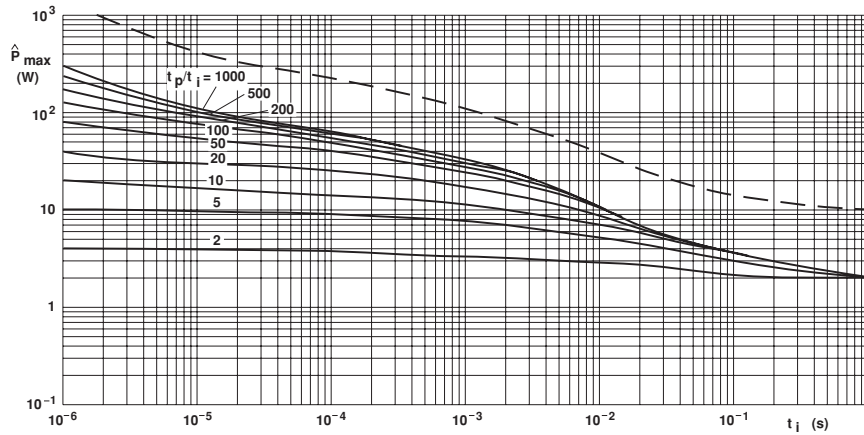

PR02 Pulse on a regular basis; maximum permissible peak pulse power (\hat{P}_{max}) as a function of pulse duration (t_i).

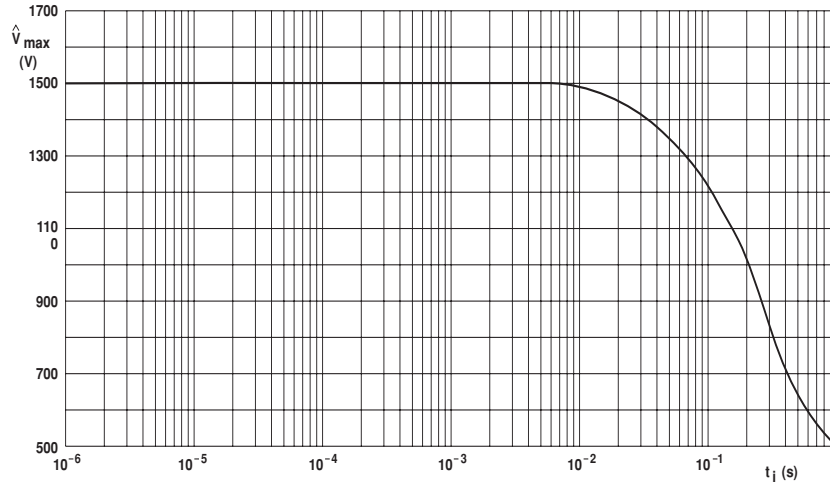

PR02 Pulse on a regular basis; maximum permissible peak pulse voltage (\hat{V}_{max}) as a function of pulse duration (t_i).

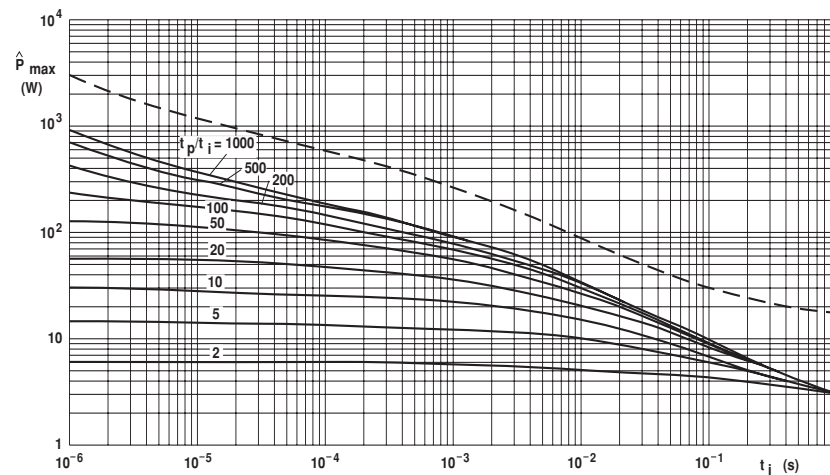

PR03 Pulse on a regular basis; maximum permissible peak pulse power (\hat{P}_{max}) as a function of pulse duration (t_i).

Pulse Loading Capabilities

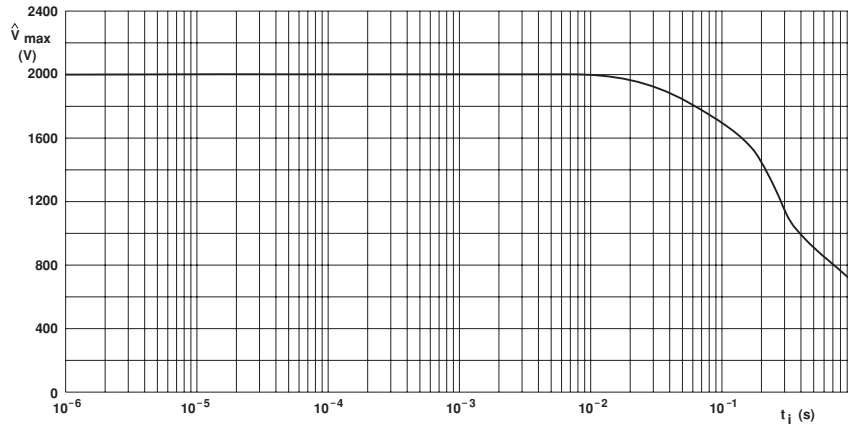

PR03 Pulse on a regular basis; maximum permissible peak pulse voltage (\hat{V}_{max}) as a function of pulse duration (t_i).

Pulse Loading Capabilities

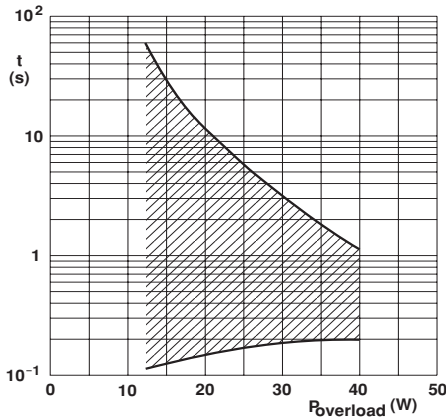

PR01 Time to interruption as a function of overload power for range: $0 R 22 \leq R_n < 1 R$.

This graph is based on measured data under constant voltage conditions; the data may deviate according to the applications.

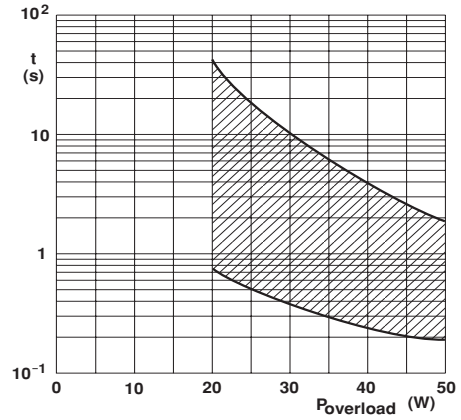

PR01 Time to interruption as a function of overload power for range: $1 R \leq R_n \leq 15 R$.

This graph is based on measured data under constant voltage conditions; the data may deviate according to the applications.

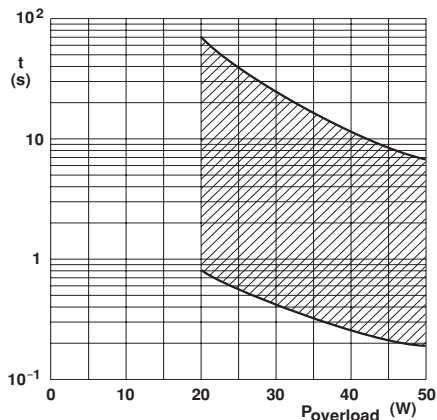

PR01 Time to interruption as a function of overload power for range: $16 R \leq R_n \leq 560 R$.

This graph is based on measured data under constant voltage conditions; the data may deviate according to the applications.

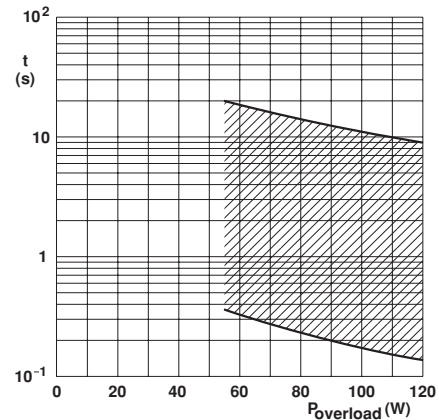

PR02 Time to interruption as a function of overload power for range: $0.33 R \leq R_n < 5 R$.

This graph is based on measured data under constant voltage conditions; the data may deviate according to the applications.

Interruption Characteristics

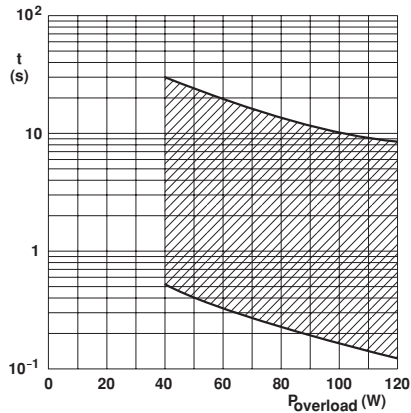

PR02 Time to interruption as a function of overload power for range: $5 R \leq R_n < 68 R$.

This graph is based on measured data under constant voltage conditions; the data may deviate according to the applications.

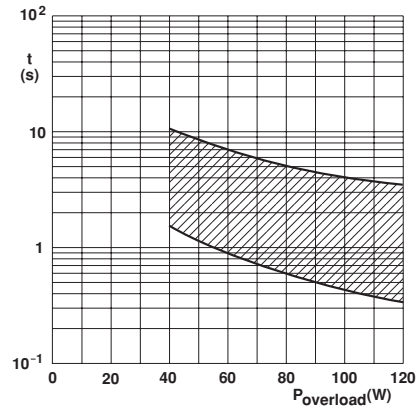

PR02 Time to interruption as a function of overload power for range: $68 R \leq R_n \leq 560 R$.

This graph is based on measured data under constant voltage conditions; the data may deviate according to the applications.

Interruption Characteristics

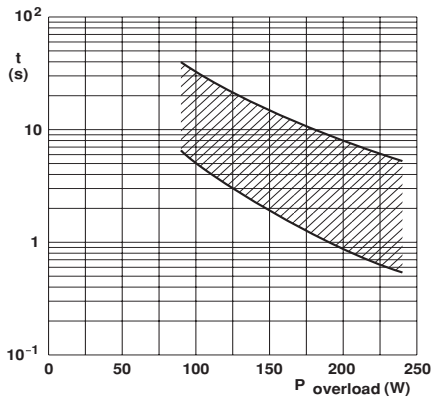

PR03 Time to interruption as a function of overload power for range: $0.68 R \leq R_n \leq 560 R$.

This graph is based on measured data under constant voltage conditions; the data may deviate according to the applications.

Interruption Characteristics

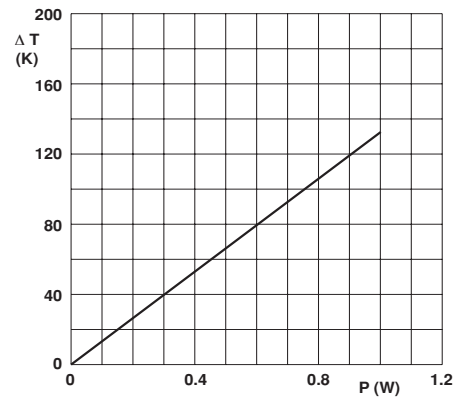

Ø0.6 mm Cu-leads.

PR01 Hot-spot temperature rise (ΔT) as a function of dissipated power.

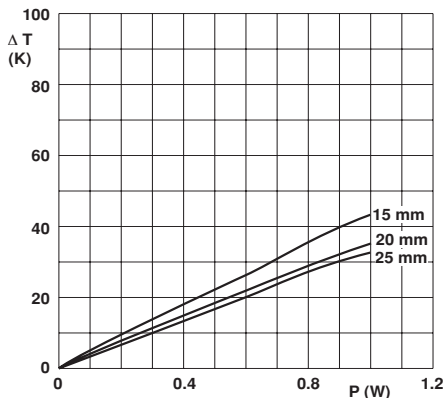

Ø0.6 mm Cu-leads.

Minimum distance from resistor body to PCB = 1 mm.

PR01 Temperature rise (ΔT) at the lead end (soldering point) as a function of dissipated power at various lead lengths after mounting.

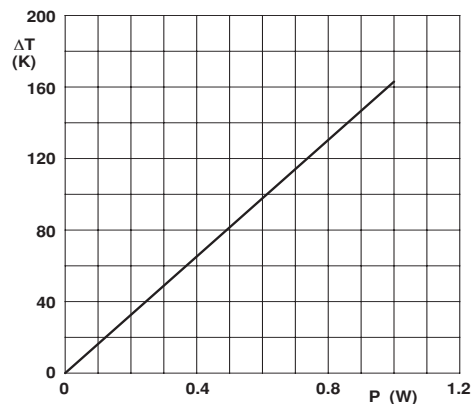

Ø0.6 mm FeCu-leads.

PR01 Hot-spot temperature rise (ΔT) as a function of dissipated power.

Application Information

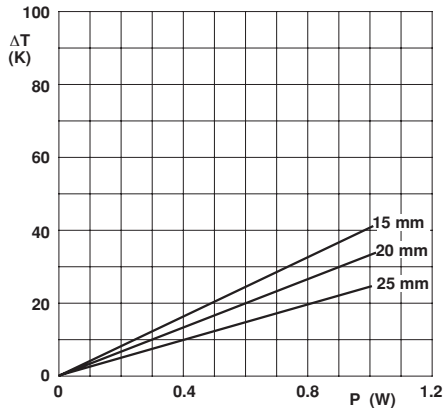

Ø0.6 mm FeCu-leads.
Minimum distance from resistor body to PCB = 1 mm.

PR01 Temperature rise (ΔT) at the lead end (soldering point) as a function of dissipated power at various lead lengths after mounting.

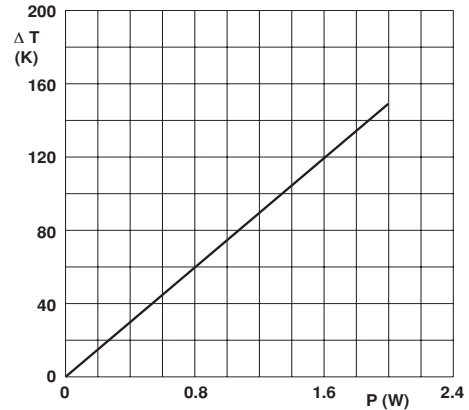

Ø0.8 mm Cu-leads.

PR02 Hot-spot temperature rise (ΔT) as a function of dissipated power.

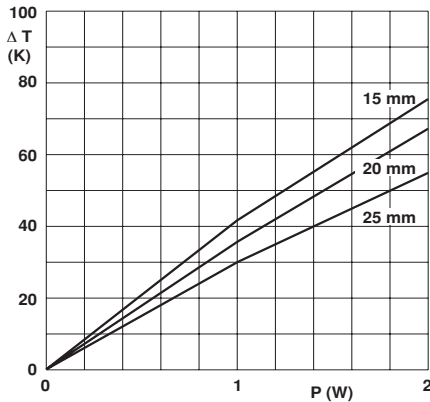

Ø0.8 mm Cu-leads.
Minimum distance from resistor body to PCB = 1 mm.

PR02 Temperature rise (ΔT) at the lead end (soldering point) as a function of dissipated power at various lead lengths after mounting.

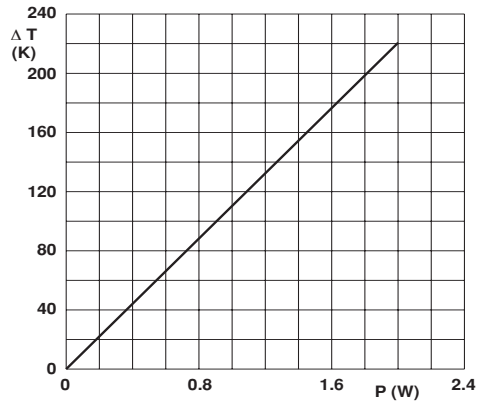

Ø0.6 mm FeCu-leads.

PR02 Hot-spot temperature rise (ΔT) as a function of dissipated power.

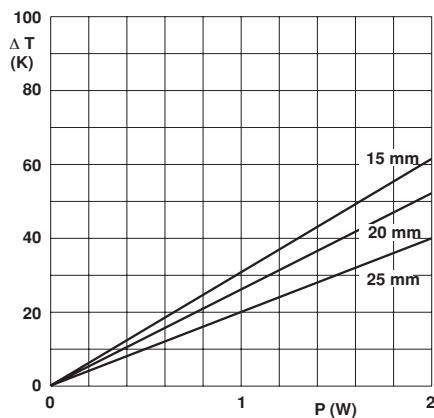

Ø0.6 mm FeCu-leads.
Minimum distance from resistor body to PCB = 1 mm.

PR02 Temperature rise (ΔT) at the lead end (soldering point) as a function of dissipated power at various lead lengths after mounting.

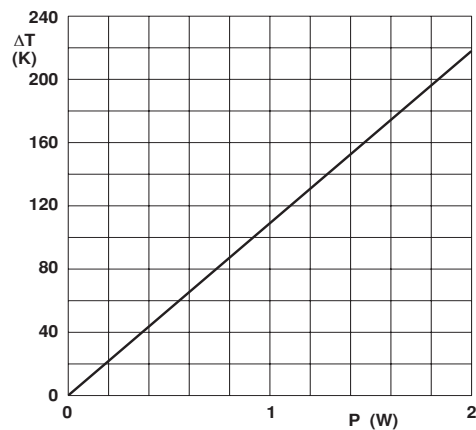

Ø0.8 mm FeCu-leads.

PR02 Hot-spot temperature rise (ΔT) as a function of dissipated power.

Application Information

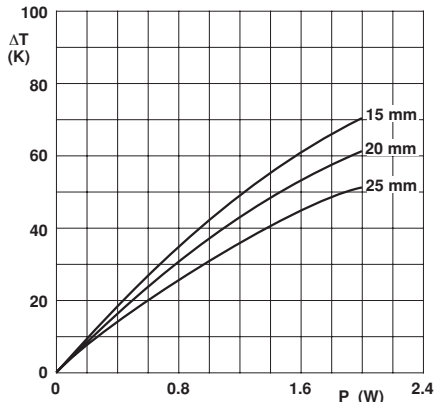

Ø0.8 mm FeCu-leads.
Minimum distance from resistor body to PCB = 1 mm.
PR02 Temperature rise (ΔT) at the lead end (soldering point) as a function of dissipated power at various lead lengths after mounting.

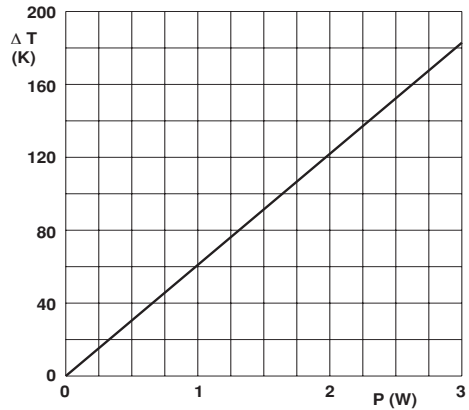

Ø0.8 mm Cu-leads.
PR03 Hot-spot temperature rise (ΔT) as a function of dissipated power.

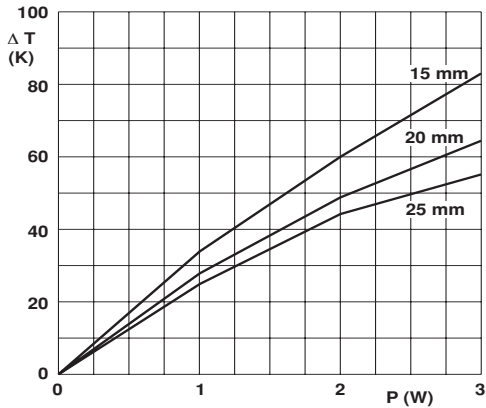

Ø0.8 mm Cu-leads.
Minimum distance from resistor body to PCB = 1 mm.
PR03 Temperature rise (ΔT) at the lead end (soldering point) as a function of dissipated power at various lead lengths after mounting.

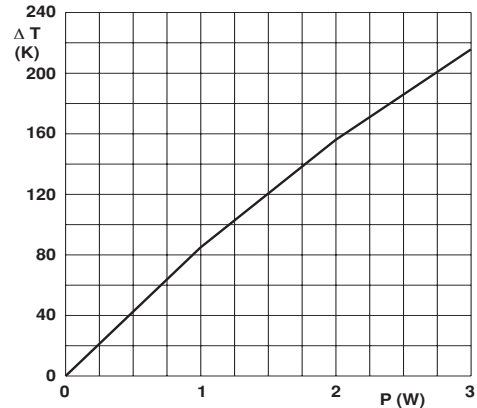

Ø0.6 mm FeCu-leads.
PR03 Hot-spot temperature rise (ΔT) as a function of dissipated power.

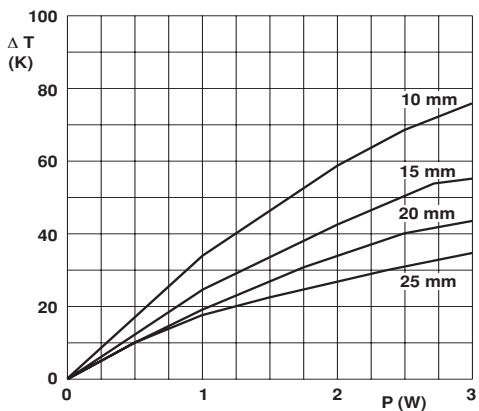

Ø0.6 mm FeCu-leads.
Minimum distance from resistor body to PCB = 1 mm.
PR03 Temperature rise (ΔT) at the lead end (soldering point) as a function of dissipated power at various lead lengths after mounting.

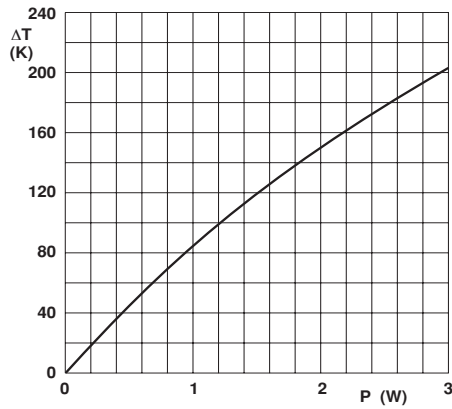

Ø0.8 mm FeCu-leads.
PR03 Hot-spot temperature rise (ΔT) as a function of dissipated power.

Application Information

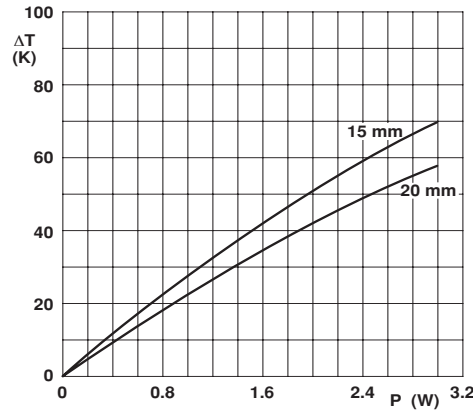

Ø0.8 mm FeCu-leads.

Minimum distance from resistor body to PCB = 1 mm.

PR03 Temperature rise (ΔT) at the lead end (soldering point) as a function of dissipated power at various lead lengths after mounting.

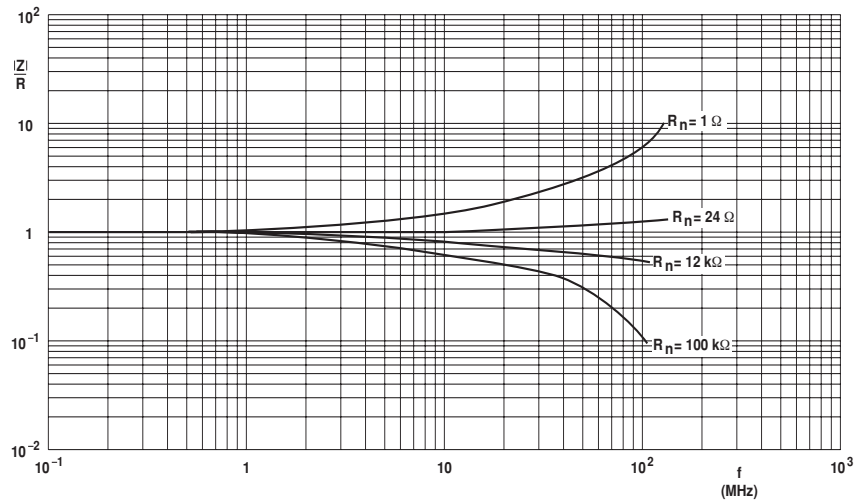

PR01 Impedance as a function of applied frequency.

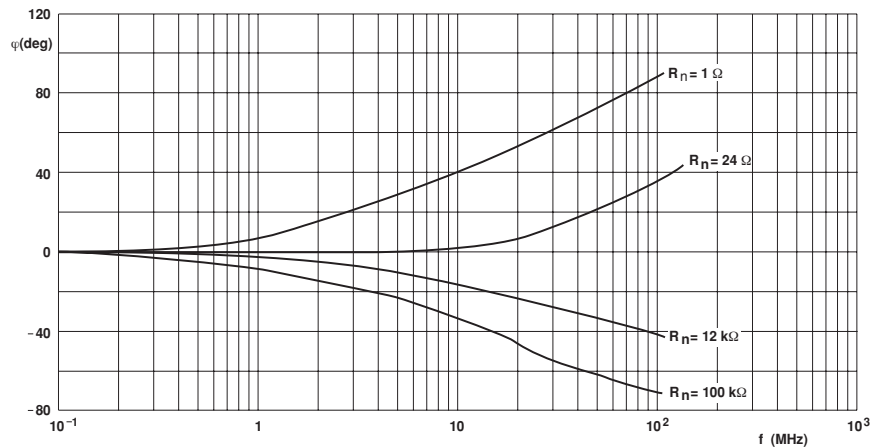

PR01 Phase angle as a function of applied frequency.

Application Information

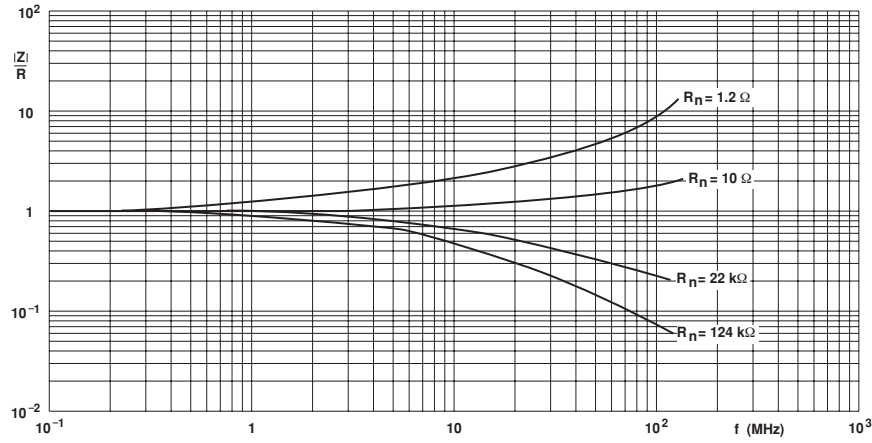

PR02 Impedance as a function of applied frequency.

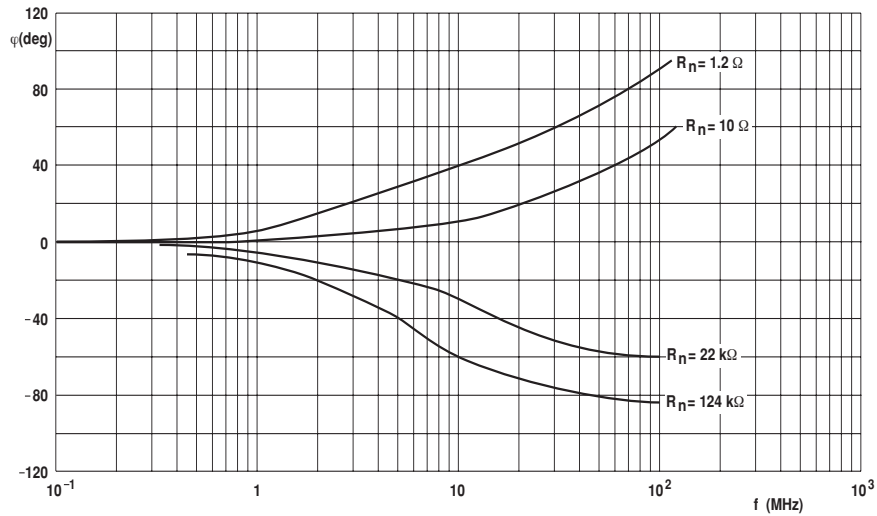

PR02 Phase angle as a function of applied frequency.

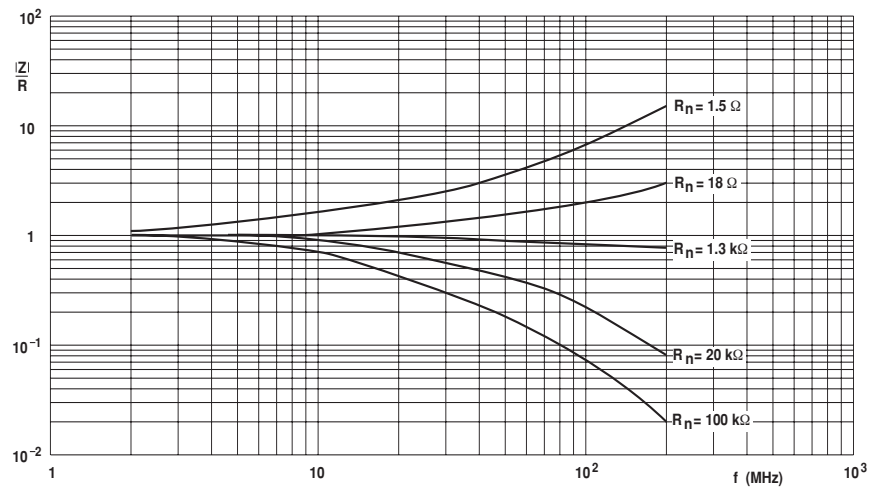

PR03 Impedance as a function of applied frequency.

Application Information

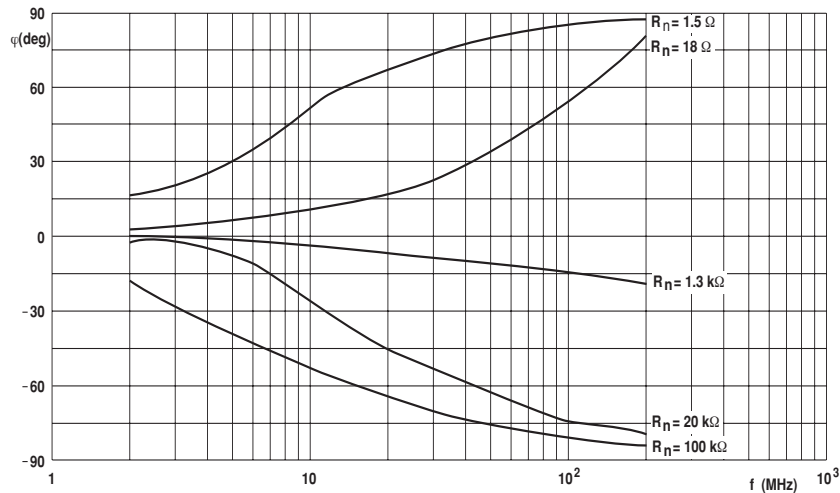
PR03 Phase angle as a function of applied frequency.

Application Information
TESTS AND REQUIREMENTS

Essentially all tests are carried out in accordance with the schedule of "IEC publication 60115-1", category LCT/UCT/56 (rated temperature range: Lower Category Temperature, Upper Category Temperature; damp heat, long term, 56 days). The testing also covers the requirements specified by EIA and EIAJ.

The tests are carried out in accordance with IEC publication 60068-2, "Recommended basic climatic and mechanical robustness testing procedure for electronic components"

and under standard atmospheric conditions according to "IEC 60068-1", subclause 5.3.

In the Test Procedures and Requirements table, tests and requirements are listed with reference to the relevant clauses of "IEC publications 60115-1 and 60068-2"; a short description of the test procedure is also given. In some instances deviations from the IEC recommendations were necessary for our method of specifying.

All soldering tests are performed with mildly activated flux.

TEST PROCEDURES AND REQUIREMENTS				
IEC 60115-1 CLAUSE	IEC 60068-2 TEST METHOD	TEST	PROCEDURE	REQUIREMENTS
TESTS IN ACCORDANCE WITH THE SCHEDULE OF IEC PUBLICATION 60115-1				
4.4.1		visual examination		no holes; clean surface; no damage
4.4.2		dimensions (outline)	gauge (mm)	see Straight & Kinked Dimensions tables
4.5		resistance	applied voltage (+ 0/-10 %): R < 10 Ω: 0.1 V 10 Ω ≤ R < 100 Ω: 0.3 V 100 Ω ≤ R < 1 kΩ: 1 V 1 kΩ ≤ R < 10 kΩ: 3 V 10 kΩ ≤ R < 100 kΩ: 10 V 100 kΩ ≤ R < 1 MΩ: 25 V R = 1 MΩ: 50 V	R - R _{nom} : max. ± 5 %
4.18	20 (Tb)	resistance to soldering heat	thermal shock: 3 s; 350 °C; 3 mm from body	ΔR/R max.: ± 1 % + 0.05 Ω
4.29	45 (Xa)	component solvent resistance	isopropyl alcohol or H ₂ O followed by brushing in accordance with "MIL 202 F"	no visual damage
4.17	20 (Ta)	solderability	2 s; 235 °C	good tinning; no damage
4.7		voltage proof on insulation	maximum voltage 500 V (RMS) during 1 minute; metal block method	no breakdown or flashover

TEST PROCEDURES AND REQUIREMENTS				
IEC 60115-1 CLAUSE	IEC 60068-2 TEST METHOD	TEST	PROCEDURE	REQUIREMENTS
4.16 4.16.2 4.16.3 4.16.4	21 (U) 21 (Ua1) 21 (Ub) 21 (Uc)	robustness of terminations: tensile all samples bending half number of samples torsion other half of samples	load 10 N; 10 s load 5 N; 4 × 90° 3 × 360° in opposite directions	number of failures: 1×10^{-6} number of failures: 1×10^{-6} no damage $\Delta R/R$ max.: $\pm 0.5\% + 0.05\ \Omega$ no damage $\Delta R/R$ max.: $\pm 0.5\% + 0.05\ \Omega$
4.20	29 (Eb)	bump	3 × 1500 bumps in three directions; 40 g	no damage $\Delta R/R$ max.: $\pm 0.5\% + 0.05\ \Omega$
4.22	6 (Fc)	vibration	frequency 10 to 500 Hz; displacement 1.5 mm or acceleration 10 g; three directions; total 6 hours (3 × 2 hours)	no damage $\Delta R/R$ max.: $\pm 0.5\% + 0.05\ \Omega$
4.19	14 (Na)	rapid change of temperature	30 minutes at LCT and 30 minutes at UCT; 5 cycles	no visual damage PR01: $\Delta R/R$ max.: $\pm 1\% + 0.05\ \Omega$ PR02: $\Delta R/R$ max.: $\pm 1\% + 0.05\ \Omega$ PR03: $\Delta R/R$ max.: $\pm 2\% + 0.05\ \Omega$
4.23 4.23.3 4.23.6	30 (Db) 30 (Db)	climatic sequence: damp heat (accelerated) 1 st cycle damp heat (accelerated) remaining cycles	6 days; 55 °C; 95 to 98 % RH	R_{ins} min.: 10 ³ M Ω $\Delta R/R$ max.: $\pm 3\% + 0.1\ \Omega$
4.24.2	3 (Ca)	damp heat (steady state) (IEC)	56 days; 40 °C; 90 to 95% RH; loaded with 0.01 P _n (IEC steps: 4 to 100 V)	R_{ins} min.: 1000 M Ω $\Delta R/R$ max.: $\pm 3\% + 0.1\ \Omega$
4.25.1		endurance (at 70 °C)	1000 hours; loaded with P _n or V _{max} ; 1.5 hours on and 0.5 hours off	$\Delta R/R$ max.: $\pm 5\% + 0.1\ \Omega$
4.8.4.2		temperature coefficient	at 20/LCT/20 °C and 20/UCT/20 °C (TC × 10 ⁻⁶ /K)	$\leq \pm 250$
OTHER TESTS IN ACCORDANCE WITH IEC 60115 CLAUSES AND IEC 60068 TEST METHOD				
4.17	20 (Tb)	solderability (after ageing)	8 hours steam or 16 hours 155 °C; leads immersed 6 mm for 2 ± 0.5 s in a solder bath at 235 ± 5 °C	good tinning (≥ 95 % covered); no damage
4.6.1.1		insulation resistance	maximum voltage (DC) after 1 minute; metal block method	R_{ins} min.: 10 ⁴ M Ω
see 2 nd amendment to IEC 60115-1, Jan. '87		pulse load		see Pulse Load Capabilities graphs